



PRO-CELL CO., LTD.

SPECIFICATION FOR APPROVAL

Customer :

Model No. : PAN-N01000-01-9

Description : 5.5~5.835GHz PANEL ANTENNA

Date : 2006/12/07

Rev : 1



PRO-CELL CO., LTD.

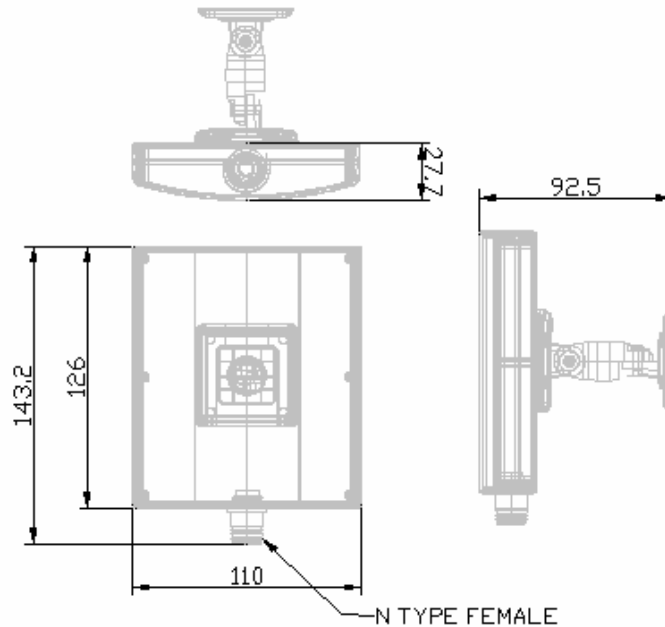

Electrical Specifications:

Frequency Range :	5.5~ 5.835 GHz
VSWR :	≤ 2.0
Impedance :	$50\Omega \pm 5\Omega$
Gain :	10 dBi
Polarization :	Vertical
Power Handling :	10 Watt
Beam Width :	H: 36° / E: 33°

Mechanical Specifications:

Connector :	SMA Male RS
Operation Temp. :	$-30^\circ\text{C} \sim +60^\circ\text{C}$
Material :	Radome: ABS Mount: ABS
Dimension (L*W*H) :	143.2*110*27.7 mm
Weight :	140g \pm 10g (w/ mount)
Color :	COOL GRAY 1C



PRO-CELL CO., LTD.

3D Illustration

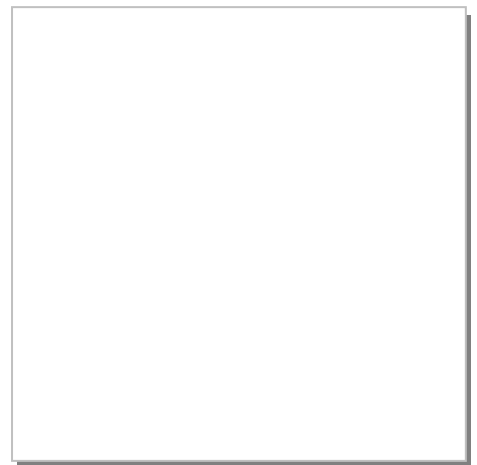
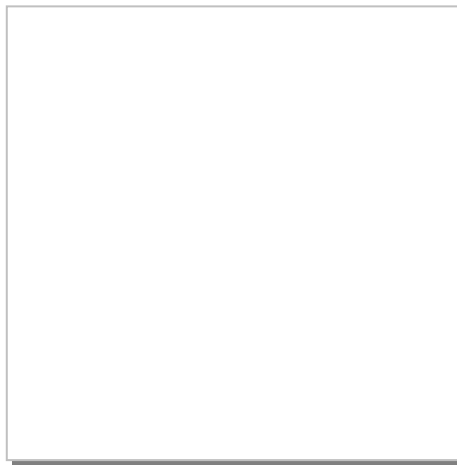
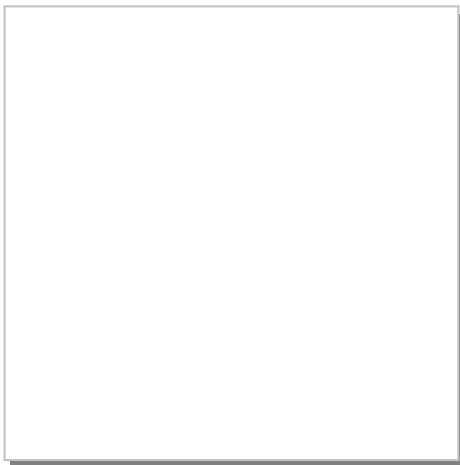

PRO-CELL CO., LTD.

No.6, Lane 133, Sec.1, Guo-Ji Road, Ta-yuan Hsiang, Taoyuan, Taiwan. R.O.C.

Tel: 886-3-3858288

Fax: 886-3-3858289

E-mail: sales@antenna.com.tw

<http://www.antenna.com.tw>



PRO-CELL CO., LTD.

RETURN LOSS

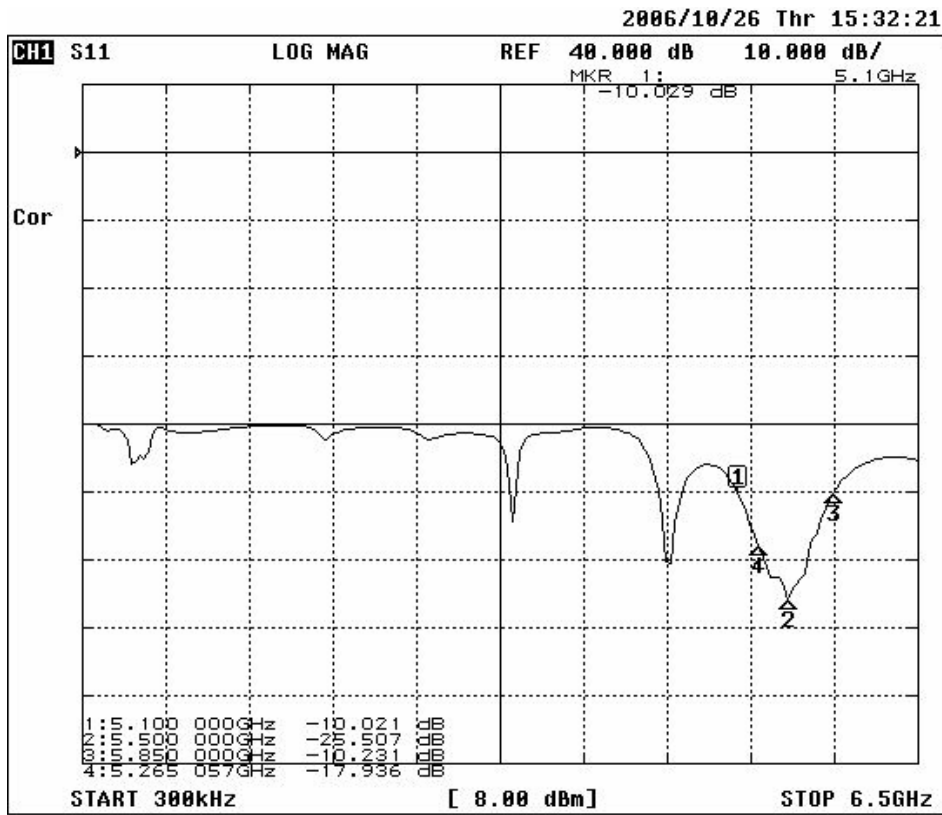

PRO-CELL CO., LTD.

No.6, Lane 133, Sec.1, Guo-Ji Road, Ta-yuan Hsiang, Taoyuan, Taiwan. R.O.C.
Tel: 886-3-3858288 Fax: 886-3-3858289
E-mail: sales@antenna.com.tw <http://www.antenna.com.tw>



PRO-CELL CO., LTD.

SWR

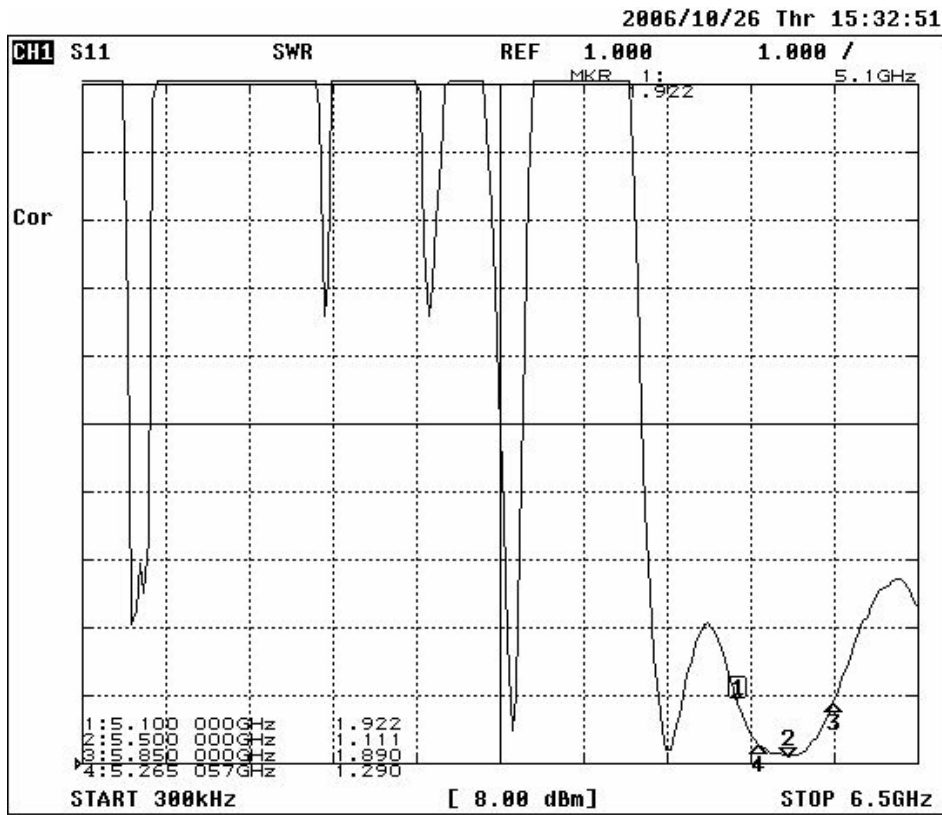



PRO-CELL CO., LTD.

H-PLANE

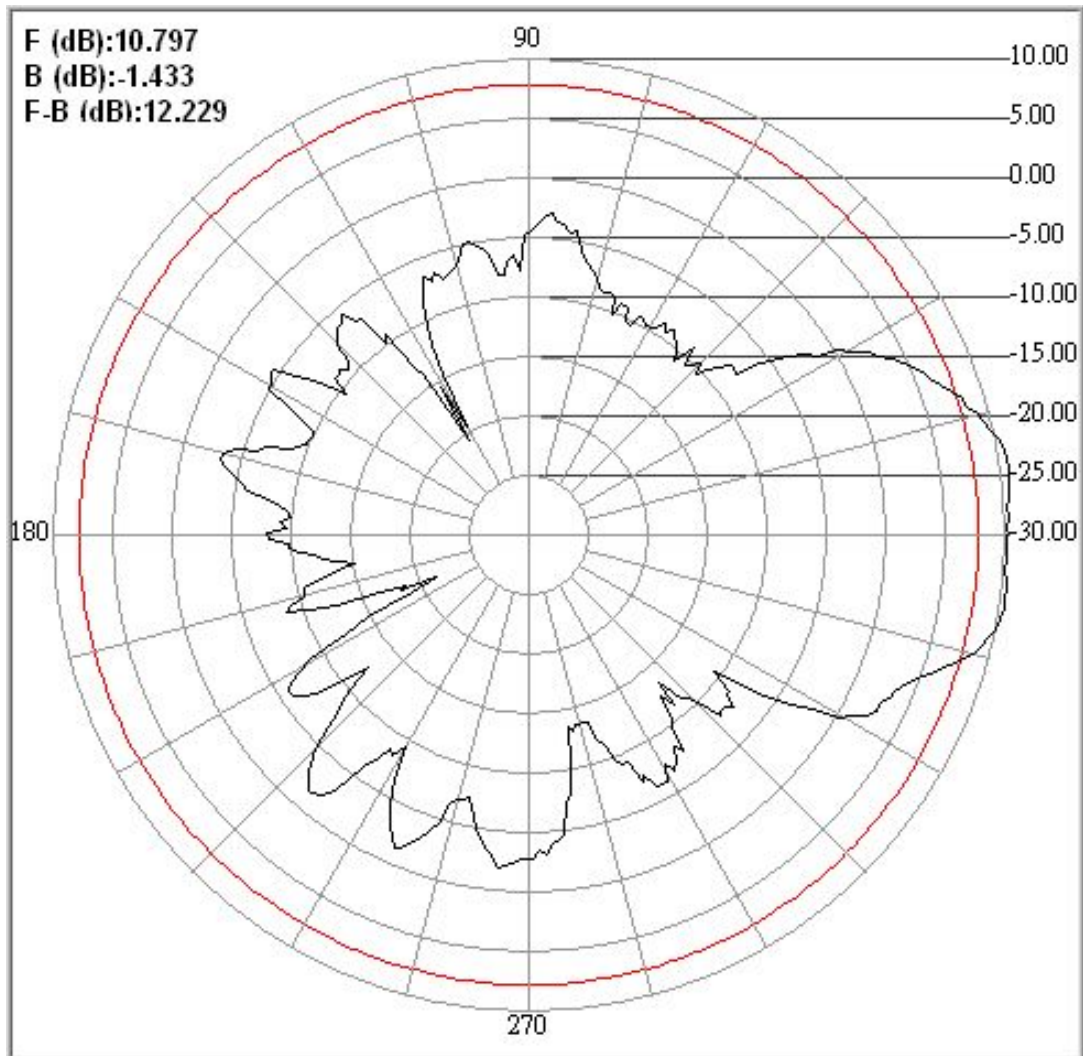

PRO-CELL CO., LTD.

No.6, Lane 133, Sec.1, Guo-Ji Road, Ta-yuan Hsiang, Taoyuan, Taiwan. R.O.C.

Tel: 886-3-3858288

Fax: 886-3-3858289

E-mail: sales@antenna.com.tw

<http://www.antenna.com.tw>



PRO-CELL CO., LTD.

E-PLANE

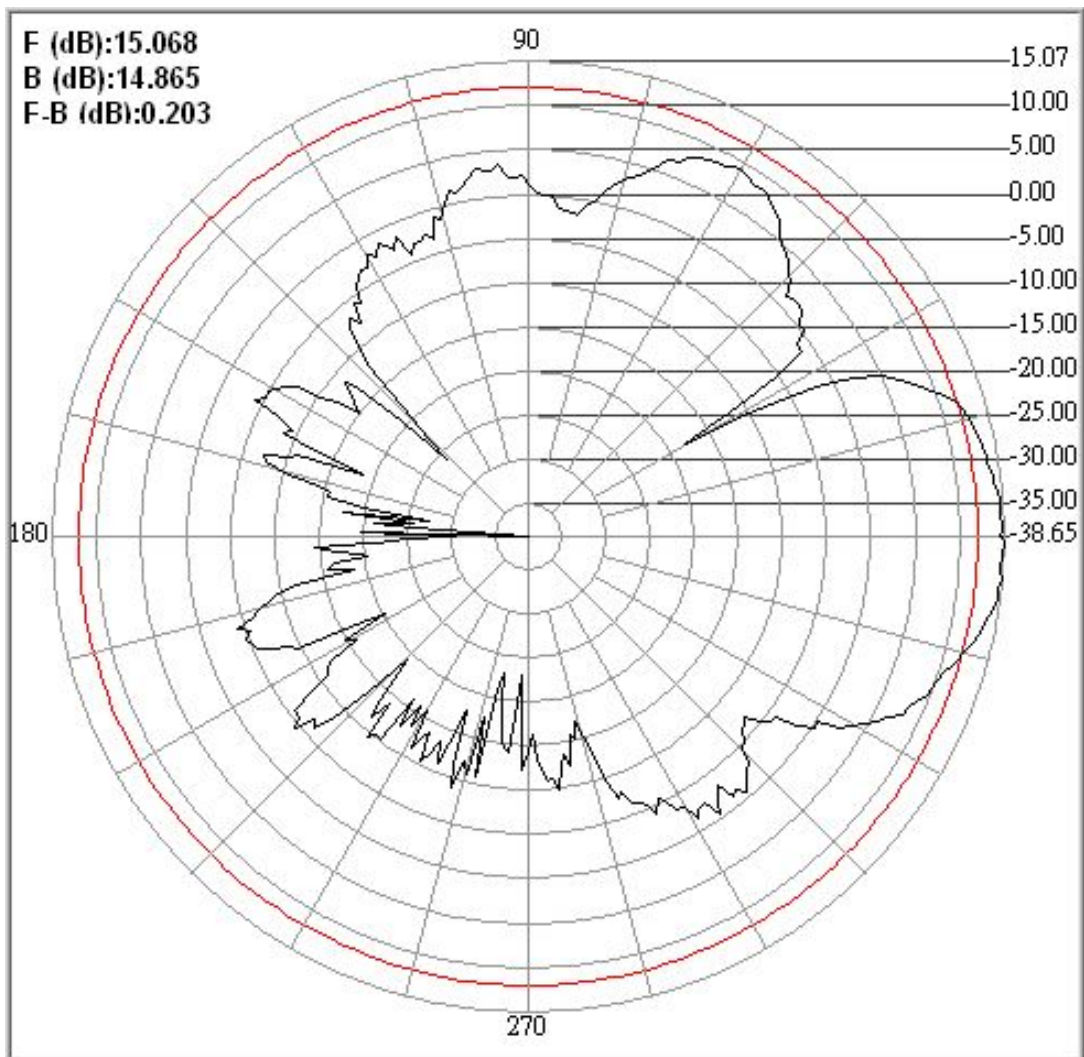

PRO-CELL CO., LTD.

No.6, Lane 133, Sec.1, Guo-Ji Road, Ta-yuan Hsiang, Taoyuan, Taiwan. R.O.C.

Tel: 886-3-3858288

Fax: 886-3-3858289

E-mail: sales@antenna.com.tw

<http://www.antenna.com.tw>